



---

# OWNER'S OPERATING MANUAL

---



## **VX-1000ci Projector & PFP™ Controller**

Widescreen Digital Light Processing™ Projector &  
Pixel For Pixel™ Controller with Vivix™ Technology



**THE WORLD'S FINEST HOME THEATER PRODUCTS™**



# Table of Contents

---

<b>Introduction</b> .....	3
<b>Warnings and Safety Precautions</b> .....	4
Warning .....	5
Safety Tips .....	5
<b>Limited Warranty</b> .....	6
<b>Features and Benefits</b> .....	8
<b>Projector Description</b> .....	9
Top View .....	9
Input Panel .....	9
<b>Projector Placement and Offset Information</b> .....	10
Ceiling Mount Configuration .....	10
Floor Mount Configuration .....	10
<b>PFP Controller Description</b> .....	11
Front Panel .....	11
Rear Panel .....	12
<b>Remote Control Description</b> .....	13
<b>Quick Set-up Guide</b> .....	14
Connection Example .....	14
<b>Overall Functional Description</b> .....	15
<b>Menu Description and Navigation</b> .....	16
Menu Tree .....	16
Main Menu .....	16
<b>Picture Quality Adjustments</b> .....	18
Main Menu .....	18
<b>Installation Menu</b> .....	21
Installation Menu .....	21
Lamp Mode .....	21
Keystone .....	21
Picture Orientation .....	22
IR Code Set .....	22
Lamp Hours .....	22
System Reset .....	22
<b>Quick Menu</b> .....	23
<b>Basic Troubleshooting Tips</b> .....	25
<b>RS-232 Communications</b> .....	27
RS-232 Commands .....	28
<b>Dimensions</b> .....	30
<b>Specifications</b> .....	32



# Introduction

---

The new VX-1000ci is the flagship of Runco International's 3rd Generation of DLP™ front projectors. Some of the GEN 3 features include an Reflectance Volume Regulation (RVR), digital video input with HDCP, 9 point Color Balance, and the ultra-high contrast 16:9 HD-2 DMD (Digital Micro-Mirror Device) from Texas Instruments'. The Reflectance Volume Regulation (RVR) allows adjustable iris control of contrast ratio versus light output for the best imaging performance in any viewing environment. The digital video input with HDCP allows for the signal to stay digital through the entire signal path. A 9-point color balance, finely adjusts color balance for better gray scale tracking than any other consumer DLP. The HD-2 DMD produces an exceptionally high contrast ratio for high light output and better black level than film. The VX-1000ci projector system also includes the PFP™ Controller for converting all NTSC or PAL signals to the native resolution of the projector for viewing in various formats. For added flexibility, electronic keystone correction and vertical lens shift provide any needed leeway when installing within confined quarters.

## Features

- Native 1280 x 720, Single HD-2 16:9 DMD Chip
- RVR or Reflectance Volume Regulation
- 16:9 Widescreen Native Resolution - Designed exclusively for 16:9 aspect screens
- Multiple aspect ratio (on 16:9 screens) - Anamorphic, Letterbox, 4:3, VirtualWide
- Contrast Ratio 2500:1 to 3000:1 Variable (depending on RVR calibration)
- Vertical lens shift
- 3:2 pulldown detection
- HDTV capable (via an outboard DTV decoder); 720 (native), 1080i, 480p, 540p
- PAL compatible
- DVI-I Input / PC Input
- Electronic Keystone Correction

## Included Accessories

- Remote Control with 2 AAA batteries
- Rack Mount hardware
- (1) 6" RGBHV extension for the Controller, (1) 9-pin to RJ-45
- Power cables (one for Projector, one for PFP Controller)
- 50' RJ-11 phone type cable
- Lens adjustment tool
- User's Manual
- Warranty information

# Warnings and Safety Precautions

---

## WARNING

FCC Regulations state that any unauthorized changes or modifications to this equipment not expressly approved by the manufacturer could void the user's authority to operate this equipment.

**CAUTION:** TO PREVENT FIRE OR SHOCK HAZARDS, DO NOT REMOVE COVER. DO NOT EXPOSE THIS UNIT TO RAIN OR MOISTURE. ALSO DO NOT USE THIS UNIT'S POLARIZED PLUG WITH AN EXTENSION CORD RECEPTACLE OR OTHER OUTLETS, UNLESS THE PRONGS CAN BE FULLY INSERTED. REFRAIN FROM OPENING THE CABINET AS THERE ARE HIGH-VOLTAGE COMPONENTS INSIDE. NO USER-SERVICEABLE PARTS EXCEPT LAMP UNIT. REFER SERVICING TO QUALIFIED SERVICE PERSONNEL.

## WARNING

High brightness light source. Do not stare into the beam of light, or view directly. Be especially careful that children do not stare directly into the beam of light.

## WARNING

The cooling fan in this projector continues to run for about 90 seconds after the projector is turned off. During normal operation, when turning the power off always use the power (OFF) button on the projector or on the remote control. Ensure the cooling fan has stopped before disconnecting the power cord. The power outlet socket should be installed as near to the equipment as possible, and should be easily accessible.

**DURING NORMAL OPERATION, NEVER TURN THE PROJECTOR OFF BY DISCONNECTING THE POWER CORD. FAILURE TO OBSERVE THIS WILL RESULT IN PREMATURE LAMP FAILURE.**

## PRODUCT DISPOSAL

This projector utilizes tin-lead solder, high intensity discharge lamp (HID lamp) containing a small amount of mercury. Disposal of these materials may be regulated due to environmental considerations. For disposal or recycling information, please contact your local authorities or, if you are located in the United States of America, the Electronic Industries Alliance: [www.eiae.org](http://www.eiae.org).

## INFORMATION

This equipment has been tested and found to comply with the limits for a Class B digital device, pursuant to Part 15 of the FCC Rules. These limits are designed to provide reasonable protection against harmful interference in a residential installation. This equipment generates, uses, and can radiate radio frequency energy and, if not installed and used in accordance with the operation manual, may cause harmful interference to radio communications. However, there is no guarantee that interference will not occur in a particular installation. If this equipment does cause harmful interference to radio or television reception, which can be determined by turning the equipment off and on, the user is encouraged to try to correct the interference by one or more of the following measures:

- Reorient or relocate the receiving antenna.
- Increase the separation between the equipment and the receiver.
- Connect the equipment into an outlet on a circuit different from that to which the receiver is connected.
- Consult the dealer or an experienced radio/TV technician for help.

## Declaration of Conformity

RUNCO PROJECTOR, MODEL VX-1000ci

This device complies with Part 15 of the FCC rules. Operation is subject to the following conditions: (1) This device may not cause harmful interference, and (2) this device must accept any interference received, including interference that may cause undesired operation.

## WARNING

Some IC chips in this product include confidential and/or trade secret property belonging to Texas Instruments. Therefore you may not copy, modify, adapt, translate, distribute, reverse engineer, reverse assemble or discompile the contents thereof.

### INTELLECTUAL PROPERTY RIGHTS ----- IMPORTANT ----- READ BEFORE USING THE PRODUCT

- Digital Light Processing, DLP, Digital Micromirror Device and DMD are trademarks of Texas Instruments.
- Microsoft and Windows are registered trademarks of Microsoft Corporation in the United States and/or other countries.
- PC/AT is a registered trademark of International Business Machines Corporation in the United States.
- Adobe Acrobat is a trademark of Adobe Systems Incorporated.
- Macintosh is a registered trademark of Apple Computer, Inc. in the United States and/or other countries.
- Minolta is a registered trademark of Minolta Co., Ltd.
- All other company or product names are trademarks or registered trademarks of their respective companies.

## SAFETY TIPS

**Please read and follow the safety precautions listed below to ensure the equipment is free from damage, and to ensure that no injury will occur as a result of improper use.**

- Do not insert any object, especially metal or liquids, into the Projector or PFP Controller.
- Do not place any objects containing water or any other liquid on top of the Projector or PFP Controller.
- Do not place the units in direct sunlight, near heaters or in extremely dusty or humid locations.
- Do not install this system outdoors or otherwise exposed to the elements.
- Do not place heavy objects on top of the Projector or Controller.
- If the power cord is damaged or frayed in any way, electrical shock and/or fire may result. Please do not place objects on the power cord, and keep the cord away from heat-emitting devices. Should the power cord become damaged in any way, please contact your Runco Dealer for a replacement cord.
- Do not remove the cover of the Projector or PFP Controller for any reason. If any problems arise with the unit, please contact a Runco Dealer or Runco International for service. Removing the covers will void the warranty.

# Limited Warranty

---

## LIMITED WARRANTY

Congratulations on your purchase of a Runco video product and welcome to the Runco family! We believe Runco produces “The World’s Finest Home Theater Products”. With proper installation, setup and care, you should enjoy many years of unparalleled video performance. Please read this consumer protection plan carefully and retain it with your other important documents.

This is a LIMITED WARRANTY as defined by the U.S. Consumer Product Warranty and Federal Trade Commission Improvement Act.

### **WHAT IS COVERED UNDER THE TERMS OF THIS WARRANTY:**

**SERVICE LABOR:** Runco will pay for service labor by an approved Runco service center when needed as a result of manufacturing defect for a period of two (2) years from the effective date of delivery to the end user.

**PARTS** (Not including projector lamp): Runco will provide new or rebuilt replacement parts for the parts that fail due to defects in materials or workmanship for a period of two (2) years from the effective date of the warranty. Such replacement parts are then subsequently warranted for the remaining portion (if any) of the original warranty period.

**LAMP:** Six months or 1000 hours (which ever comes first).

### **WHAT IS NOT COVERED UNDER THE TERMS OF THIS WARRANTY:**

This warranty only covers failure due to defects in materials and workmanship that occur during normal use and does not cover normal maintenance. This warranty does not cover cabinets or any appearance item; any damage to laser discs; failure resulting from accident, misuse, abuse, neglect, mishandling, misapplication, faulty or improper installation or setup adjustments; improper maintenance, alteration, improper use of any input signal; damage due to lightning or power line surges, spikes and brownouts; damage that occurs during shipping or transit; or damage that is attributed to acts of God. In the case of remote control units, damage resulting from leaking, old, damaged or improper batteries is also excluded from coverage under this warranty.

**CAUTION:** DAMAGE RESULTING DIRECTLY OR INDIRECTLY FROM IMPROPER INSTALLATION OR SETUP IS SPECIFICALLY EXCLUDED FROM COVERAGE UNDER THIS WARRANTY. IT IS IMPERATIVE THAT INSTALLATION AND SETUP WORK BE PERFORMED ONLY BY AN AUTHORIZED RUNCO DEALER TO PROTECT YOUR RIGHTS UNDER THIS WARRANTY. THIS WILL ALSO ENSURE THAT YOU ENJOY THE FINE PERFORMANCE YOUR RUNCO PRODUCT IS CAPABLE OF PROVIDING WHEN INSTALLED AND CALIBRATED BY RUNCO AUTHORIZED PERSONNEL.

### **RIGHTS, LIMITS AND EXCLUSIONS:**

Runco limits its obligations under any implied warranties under state laws to a period not to exceed the warranty period. There are no express warranties. Runco also excludes any obligation on its part for incidental or consequential damages related to the failure of this product to function properly. Some states do not allow limitations on how long an implied warranty lasts, and some states do not allow the exclusion or limitation of incidental or consequential damages. So the above limitations or exclusions may not apply to you. This warranty gives you specific legal rights, and you may also have other rights that vary from state to state.



---

**EFFECTIVE WARRANTY DATE:**

This warranty begins on the effective date of delivery to the end user. For your convenience, keep the original bill of sale as evidence of the purchase date.

**IMPORTANT: WARRANTY REGISTRATION:**

Please fill out and mail your warranty registration card. It is imperative that Runco knows how to reach you promptly if we should discover a safety problem or product update for which you must be notified.

**TO OBTAIN SERVICE, CONTACT YOUR RUNCO DEALER:**

Repairs made under the terms of the Limited Warranty covering your Runco International video product will be performed at the location of the product, during usual working hours, providing location of product is within normal operating distance from a Runco Authorized Service Center. If, solely in Runco's judgement, location of product to be repaired is beyond normal operating distance of the closest Runco Authorized Service Center, it is the owner's responsibility to arrange for shipment of the product for repair. These arrangements must be made through the selling Runco dealer. If this is not possible, contact Runco directly for a return authorization number and shipping instructions. Runco will return product transportation prepaid in the United States, unless no product defect is discovered. In that instance, shipping costs will be the responsibility of the owner.

**ADDITIONAL INFORMATION:**

To locate the name and address of the nearest Runco Authorized Service location, or for additional information about this warranty, please call, write or visit our website:

CUSTOMER SERVICE DEPARTMENT  
RUNCO INTERNATIONAL  
2900 Faber Street  
Union City, CA 94587  
Ph: (510) 324-7777 / Fax: (510) 324-9300  
[www.runco.com](http://www.runco.com)

# Features and Benefits

---

**The VX-1000ci system is a very unique system and has many important features, including:**

- Native 1280 x 720, Single HD-2, 16:9 DMD™ Chip creates images with appropriate black levels in darkened scenes.
- DVI input allows digital connections for a richer pixel for pixel and direct digital signal.
- RVR or Reflectance Volume Regulation, a GEN 3 engineering advancement. It allows the Installer to adjust light output vs. contrast ratios for proper image quality in any viewing environment.
- Full control of the Projector via the PFP Controller. This control includes all image quality adjustments as well as Projector adjustments such as image configuration.
- 1500 ANSI lumens light output.
- Lamp life with approximately 2000 hour life span.
- An adaptive two-dimensional comb filter that greatly reduces artifacts when using Composite video.
- A Luma edge enhancement circuit makes the edges of objects appear sharper without the ringing and noise associated with traditional sharpness circuits.
- A Chroma edge enhancement circuit is included to compensate for lower chroma resolution found in composite and S-Video.
- Inverse telecine (3:2 pulldown) detection and processing allows the scaler to completely eliminate interlace artifacts associated with other scalers.
- A Time Base corrector circuit is provided for unstable sources such as VCRs.
- 12v outputs for drop screens and screen masking.
- Automatic switching between NTSC and PAL signals.
- Fully RS-232 controllable, with direct access to sources and aspect ratios.
- A simple remote controls all aspects of operation, and includes discreet on/off, aspect ratio and source selection commands.
- Input 5 terminal for DVI (Digital, Computer RGB and Component)

# Projector Description

## Top View

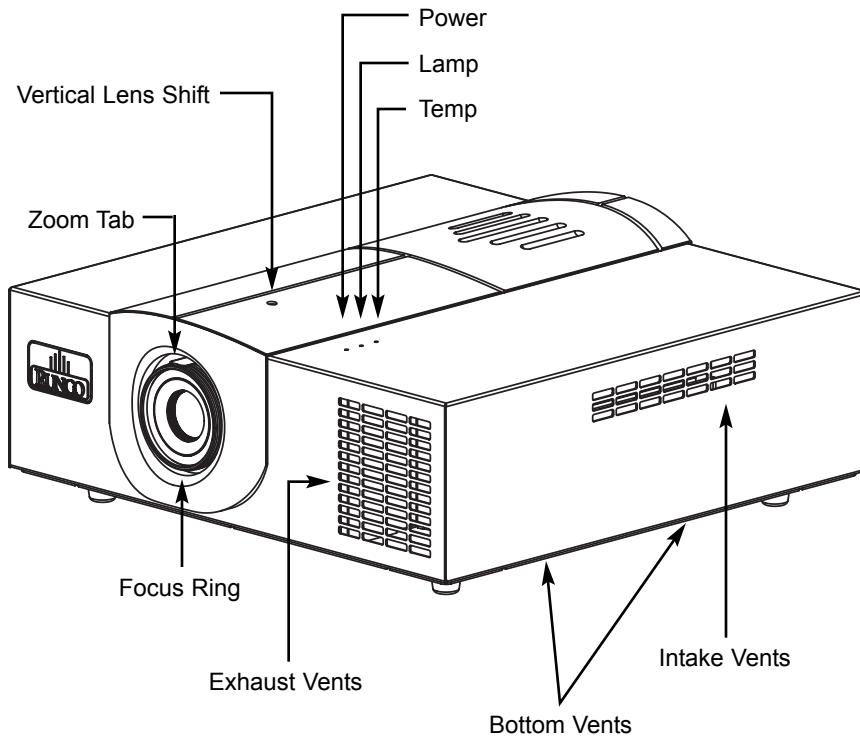

**Focus Ring:** Turn this ring to focus the image.

**Zoom Tab:** Turn this tab to make the image larger or smaller.

**Vertical Lens Shift:** Using the provided adjustment tool, turn this to move the lens up and down.

**Power:** Led is red when unit is in standby, blue when it is in operation.

**Lamp:** When the lamp is on, this LED is blue. When the lamp is off, this LED is off.

**Temp:** If the Projector has overheated and shut down, this will light red.

**Intake Vents:** This is where cooler air enters the Projector. Ensure that it is never blocked or overheating will result.

**Exhaust Vents:** This is where hot air exits the Projector. This air can be quite hot. Ensure that there are no heat-sensitive objects near it and that it is never blocked.

**Reflectance Volume Regulation (RVR):** Allows adjustable iris control of contrast ratio versus light output for the best imaging performance.

## Input Panel

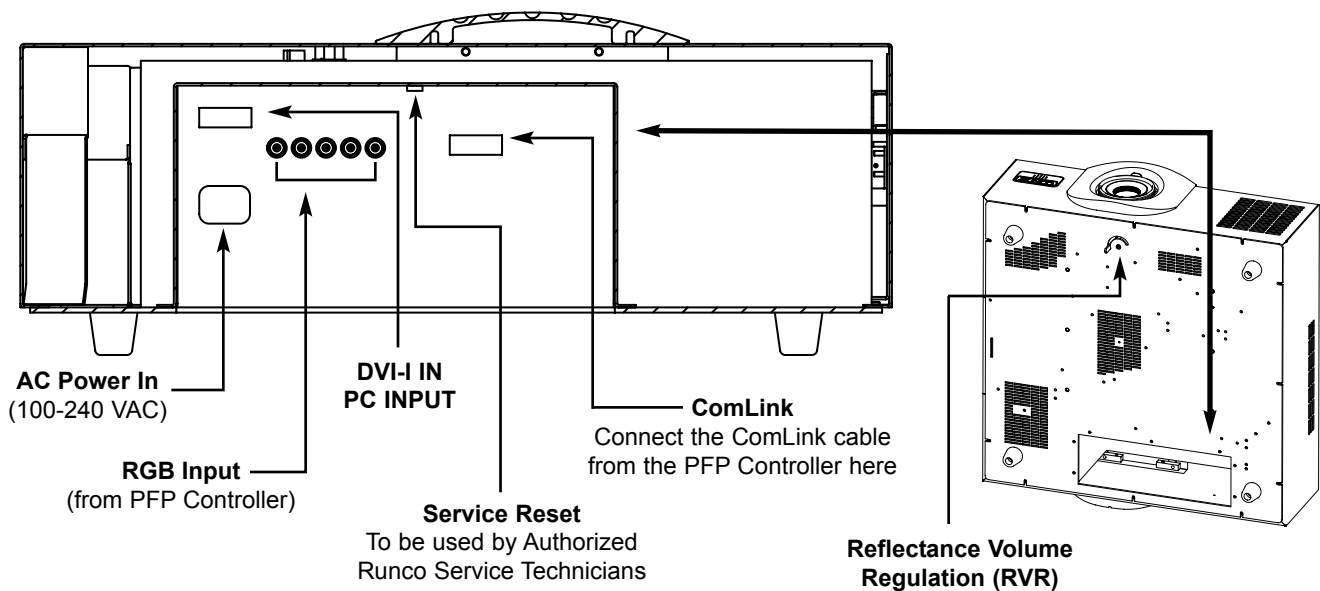

# Projector Placement and Offset Information \_\_\_\_\_

## Ceiling Mount Configuration

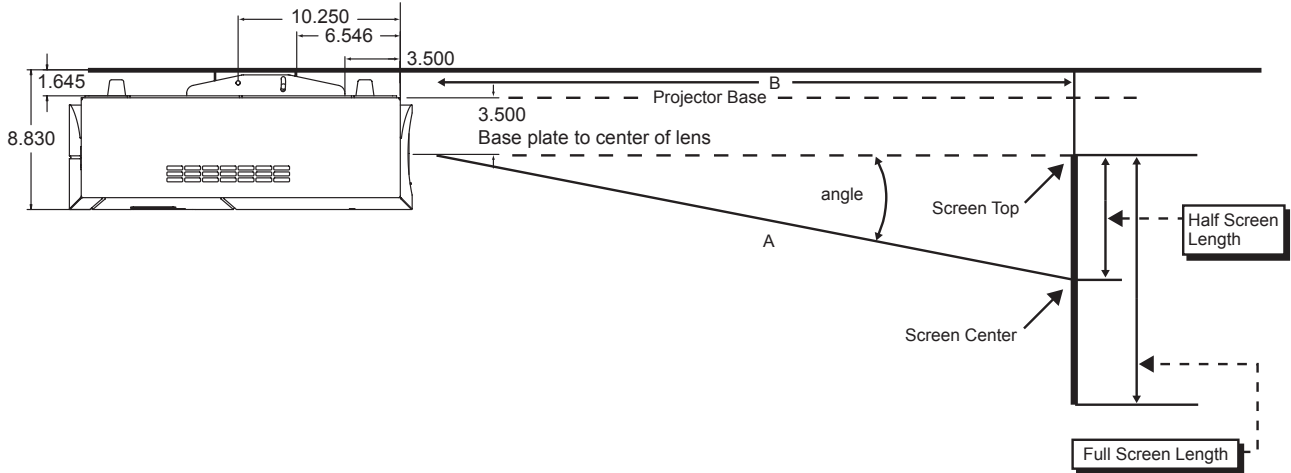

**SCREEN \_\_\_\_\_ (H) x \_\_\_\_\_ (W)**

**B) THROW DISTANCE FOR 16 x 9 SCREENS:**  
 Minimum: = (screen width x 1.85) = \_\_\_\_\_ inches  
 Maximum: = (screen width x 2.4) = \_\_\_\_\_ inches

**C) VERTICAL OFFSET:**  
 Distance between lens center and top edge of viewing area  
 (bottom edge for floor mount): Between 0 and (0 - screen height)

**NOTE:** These figures are the same for both ceiling and floor configurations.

## Floor Mount Configuration

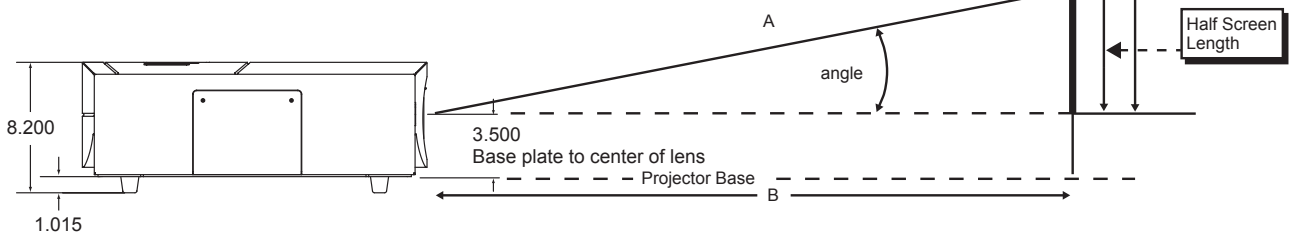

# PFP Controller Description

## Front Panel

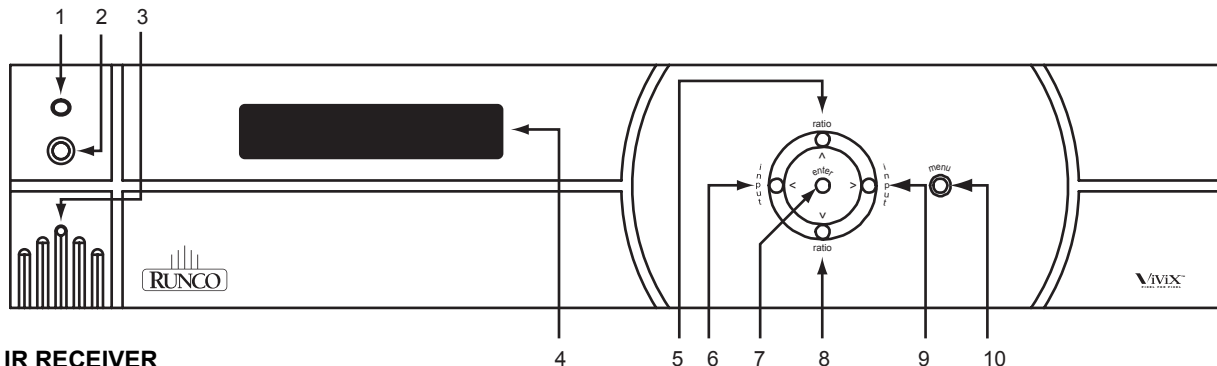

1. **IR RECEIVER**  
Receives the infrared signal from the remote control.
2. **POWER BUTTON**  
Turns the unit ON or OFF. The Main Power switch on the rear of the unit must be on first for this button to be active.
3. **POWER INDICATOR**  
When the PFP Controller is ON, this LED will illuminate GREEN. When the unit is in STANDBY, this LED will illuminate RED. A flashing red light indicates a fault. If this happens, unplug the unit for 2 minutes and re-try. A yellow LED indicates a communication problem; double check that the ComLink cable is connected properly (page 14).
4. **LED DISPLAY**  
Indicates the model number, current source, resolution and aspect ratio.
5. **UP BUTTON**  
When no menu is present on-screen, this button will toggle you through the different aspect ratios.  
When the menu is on-screen, the UP button will move the cursor up within a menu.  
When an adjustment item has been selected (i.e. brightness), the UP button will increase the value of that function.
6. **LEFT BUTTON**  
When no menu is present on-screen, the LEFT button will toggle you through the five different sources, in the order of:  
**DVI** → **RGB HD** → **Component HD** → **Component** → **S-Video** → **Composite**
7. **ENTER BUTTON**  
When an item is highlighted on the On-Screen Display, the ENTER button will select the item. When no menus are active (on screen) and the service mode is active, the ENTER button will enable the 'Quick Menu' on the front panel (see page 23).
8. **DOWN BUTTON**  
When no menu is present on-screen, this button will toggle you through the different aspect ratios.  
When the menu is on-screen, the DOWN button will move the cursor down within a menu.  
When an adjustment item has been selected (i.e. brightness), the DOWN button will decrease the value of that function.
9. **RIGHT BUTTON**  
When no menus are present on-screen, the RIGHT button will toggle you through the five different sources, in the order of:  
**Composite** → **S-Video** → **Component** → **Component HD** → **RGB HD** → **DVI**
10. **MENU BUTTON**  
The MENU button brings up the main adjustment menu. After making adjustments, the MENU button will bring you back to the sub-menu, then to the main menu. The menu will then either time-out after approximately 10 seconds, or pressing the MENU button will remove the menu immediately.

## Rear Panel

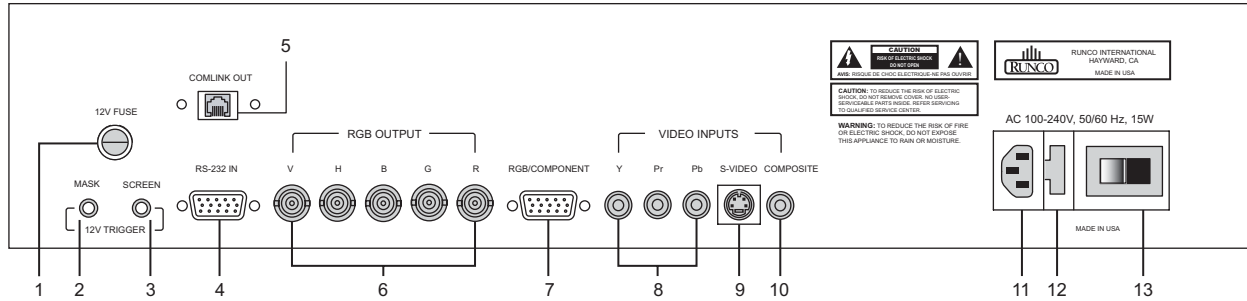

### 1. 12v FUSE

This fuse protects the 12v outputs from the MASK and SCREEN jacks.  
(Screen Fuse: 5mm x 25mm, AGC, 0.5A, 250V, Fast Blow)

### 2. MASK

This is a 12V output that can be used to trigger curtains, lifts, etc. (1/4A maximum load).

### 3. SCREEN

This is a 12V output that can be used to trigger curtains, lifts, etc. (1/4A maximum load).

### 4. RS-232 IN

This is for systems using serial (RS-232) to control the PFP Controller.  
Please refer to page 27 for RS-232 protocol and information.

### 5. COMLINK OUT

The output of this jack must be connected to the ComLink input of the VX-1000ci. If this is not connected, neither the PFP Controller or the Projector can operate and the power indicator on the front panel will stay yellow.

### 6. RGB OUTPUT

This is the main output of the PFP Controller. The RGB Signal goes directly to the Projector. If Component is used through the RGB/Component, then only the R (Pr), G(Y) and B(Pb) jacks will be active. Individually, the jacks are: V=vertical sync, H=horizontal sync, B=Blue, G=Green, R=Red.

### 7. RGB/COMPONENT

Anything input to this port will by-pass the processing of the PFP Controller and be sent straight to the display. This is useful for HDTV signals which do not require processing.

### 8. COMPONENT INPUT (480i ONLY)

This is the input for **Component Video** from sources such as DVD players.

**Note:** The component output from a DTV decoder or a progressive-scan DVD cannot be used with this port; it must be used with the RGB/Component port.

### 9. S-VIDEO INPUT

This is the input for **S-Video** from sources such as satellite receivers, S-VHS VCR's and DVD players.

### 10. COMPOSITE VIDEO INPUT

This is the input for **Composite Video** from sources such as laser disc players, VCRs and other misc. sources.

### 11. POWER INPUT

Plug in Main Power here.

### 12. 115 VAC FUSE

This is the main AC Input fuse (.5A/250V).

### 13. MAIN POWER SWITCH

Disconnects or applies main power to the Controller.

# Remote Control Description

## A. IR OUTPUT INDICATOR

Illuminates when a button is pressed, indicating that an IR signal is being transmitted.

## B. POWER BUTTON

Toggles the power on and off. For a discrete on or off command, you can use the direct access buttons (see 'J'). **Note:** When the main AC power switch is first turned ON, the PFP Controller will go through an initiation cycle for approximately 15 seconds. The PFP Controller cannot be turned on or operated until the initialization is complete.

## C. UP BUTTON

When no menus are present on-screen, the UP button will toggle you through aspect ratios in the following order:

**VirtualWide → Letterbox → Standard (4:3) → Anamorphic**

When the menu is on-screen, the UP button will move the cursor up within the menu. When an adjustment item has been selected (i.e. brightness), the UP button will increase the value of that function.

## D. LEFT BUTTON

When no menus are present on-screen, the LEFT button will toggle you through the six different sources in the following order:

**DVI → RGB HD → Component HD → Component → S-Video → Composite**

## E. DOWN BUTTON

When no menus are present on-screen, the DOWN button will toggle you through aspect ratios in the following order:

**Anamorphic → Standard (4:3) → Letterbox → VirtualWide**

When the menu is on-screen, the DOWN button will move the cursor down within the menu. When an adjustment item has been selected (i.e. brightness), the DOWN button will decrease the value of that function.

## F. RIGHT BUTTON

When no menus are present on-screen, the RIGHT button will toggle you through the six different sources in the following order:

**Composite → S-Video → Component → Component HD → RGB HD → DVI**

## G. MENU BUTTON

Pressing the MENU button will bring up the main menu. If no action is taken within approximately 10 seconds, the menu will time-out (disappear). Also, if you are in an adjustment mode or function, pressing MENU will bring the menu back one level.

## H. ENTER BUTTON

When an item is highlighted on a menu, pressing ENTER will select that item.

## I. PROGRAM BUTTON

If the remote control loses its 'memory' as a result of weak or dead batteries, it must be re-programmed for the **Controller's** code set. To reprogram the remote to the default IR Code Set, press the PROGRAM button followed by 0,1,3. If you have set the Controller for a different Code Set (see pg. 22), enter that number instead of 0,1,3.

**Note:** Pressing Enter after typing in the code is not necessary.

## J. DIRECT ACCESS BUTTONS

These buttons will allow you to directly access an aspect ratio, source, or turn the unit on or off without having to go through any menus. These buttons are:

- 1: Selects COMPOSITE video
- 2: Selects S-VIDEO
- 3: Selects COMPONENT video
- 4: Selects COMPONENT HD

- 5: Selects RGB HD
- 6: Enables or disables the Installation Menu (see page 21)
- 7: Selects the ANAMORPHIC aspect ratio
- 8: Selects the STANDARD (4:3) aspect ratio
- 9: Selects the LETTERBOX aspect ratio
- 0: Turns the PFP Controller ON.
- OFF:** Also known as the button left of '0', this turns the PFP Controller OFF.

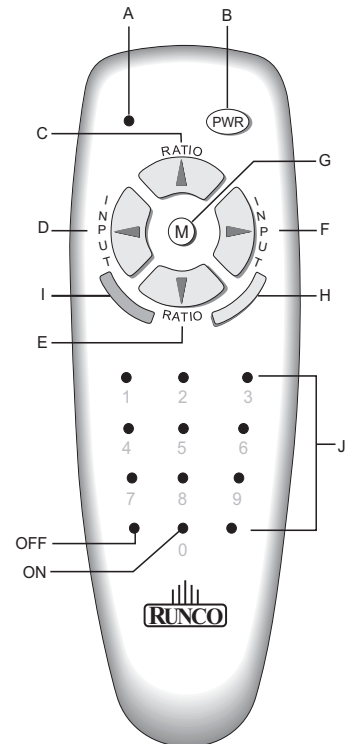

# Quick Set-up Guide

## Connection Examples

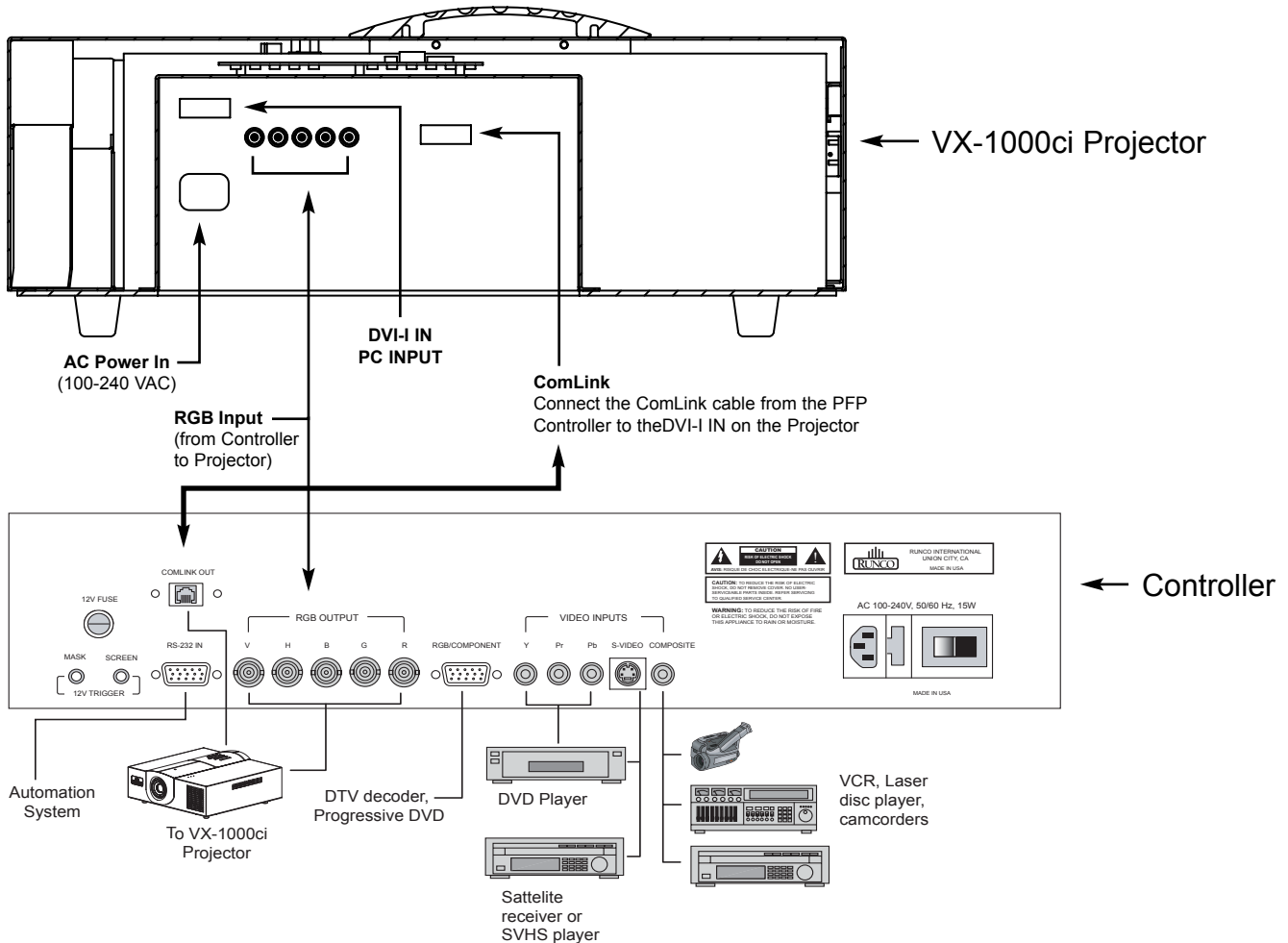

While there are many different ways to connect your source equipment to your Controller, the examples shown above are the most common and are recommended by Runco.

- **COMPOSITE VIDEO INPUT:** Composite video is the most common type of signal used, but is also the lowest in picture quality. Many sources have outputs that are limited to Composite video, such as some VCR's and camcorders. Others, such as laser disc players, actually produce slightly better results when using Composite video. While the Controller has an excellent decoder for Composite video, it is recommended that Composite video be used only if necessary.

- **S-VIDEO INPUT:** S-Video is the second-best type of signal that can be used, but is MUCH better than Composite video. Using such sources as satellite receivers, high-quality VCRs and DVD players (with no Component output) will produce a MUCH cleaner and sharper signal. Decoder artifacts that are associated with Composite video (dot crawl and 'rainbows') are non-existent when using S-Video.

- **COMPONENT INPUT:** Component video is the best type of signal that can be used. The most common sources that use Component outputs are DVD players, and it is highly recommended that Component be used when possible. Component video goes one step beyond S-Video in picture quality; chroma (color) information is more resolved and the overall picture appears more well-defined.

- **RGB/COMPONENT INPUT:** This port is where all high-resolution signals (such as computers, DTV decoders and progressive DVD players) must be input. The signal type can be either RGBHV or Component and is not processed by the Controller.



## Overall Functional Description

---

The **VX-1000ci system** consists of the **VX-1000ci Projector and PFP Controller**. This system is unique in the way it is controlled; the control center for this system is located within the PFP Controller. The PFP Controller tells the Projector to turn on or off, controls its brightness, contrast, color temperature and more. All of this is accomplished by Runco's unique ComLink, which is the transfer of information between the PFP Controller and the Projector via their ComLink ports on a CAT5 cable (or similar) with RJ-11 ends. Therefore, only the PFP Controller's remote control is necessary to control all aspects of this system.

Besides being the system's control center, the PFP Controller is also a high-quality scaler, which outputs all signals in the native resolution of the VX-1000ci Projector. The Composite, S-Video and Component (non-progressive) signals are sent through the PFP Controller's 10-bit decoder, de-interlaced, then scaled to the native resolution of the Projector. In the case of HDTV or progressive DVD signals, these are input to the RGB/Component port.

In the next chapter, the menu system will be described in detail. There are many adjustments available to perfect the VX-1000ci's image, including typical 'front-panel controls' as well as color temperature and other image-quality controls.

# Menu Description and Navigation

## Menu Tree

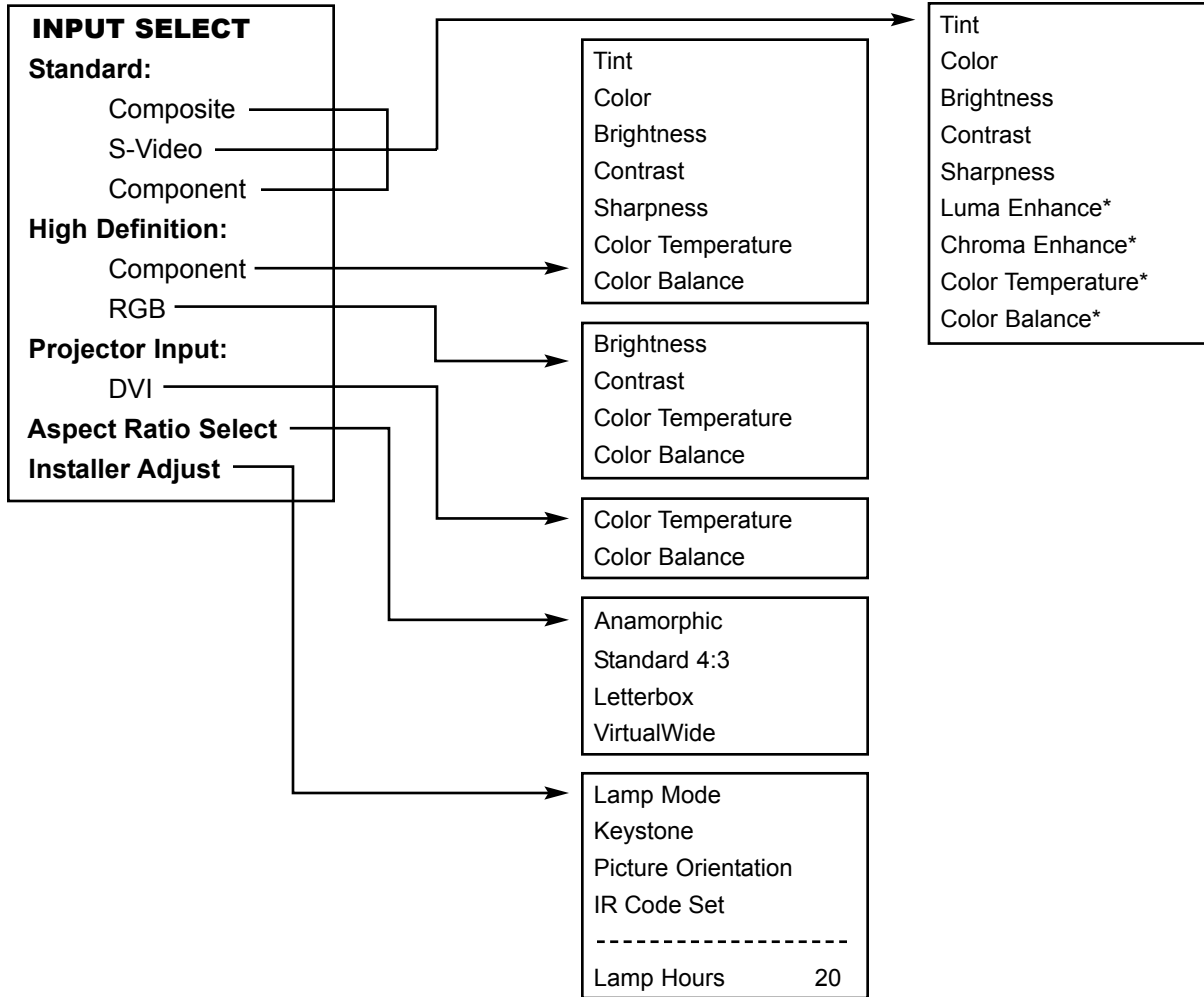

The menu tree above is an overall glance at the menu system in the VX-1000ci. This menu is shown with the installation mode enabled.

\* These menu items will only appear if the installation mode is enabled (pg. 21).

## Main Menu

The main menu includes three main sections: **Source Selection (Composite, S-Video, Component and High Definition)** (either RGB or Component and the DVI Input on the Projector), **Aspect Ratio** and **Installation**. Highlight an item on the screen using the green selection cursor and press ENTER on the remote or front panel to select and make adjustments.

---

**Source Selection** is done by highlighting the desired source with the up or down arrows and pressing ENTER. Sources may also be selected by pressing the left or right arrows on the front panel or remote, or by one of the direct access buttons on the remote (page 13). Picture adjustments such as color, tint, brightness, etc, are unique per source. To select a high-resolution source (input to the RGB/Component 15PIN input on the PFP Controller), select either RGB HD or Component HD as appropriate. If you wish to use the DVI input on the Projector, select DVI. The Controller will switch the Projector's inputs accordingly.

**Aspect Ratio** selection is done by highlighting 'Aspect Ratio' on the main menu and pressing enter. The Aspect Ratio menu will then appear; and either ANAMORPHIC, LETTERBOX, VIRTUALWIDE or 4:3 may be selected. Aspect ratios may also be selected by pressing either the up or down arrow buttons, or by one of the direct access buttons on the remote. (Note: There is no discrete access for VirtualWide).

**Installation** is used for adjustments usually made during the initial installation. This includes Lamp Mode, Keystone and Picture Orientation. *Lamp Mode* allows you to select between 'Normal' (full light output) and 'Low' (80% of full light output). *Keystone* allows the adjustment of trapezoidal distortion caused by angling the Projector; picture for ceiling or floor, front or rear installations. *IR Code Set* allows the Controller to be set to one of four different IR Code Sets. This is useful if one of the Code Sets has commands that are conflicting with other equipment, or other manufacturer's IR Codes are conflicting with the Controller. *Lamp Hours* may be checked in the Installation Menu as well.

# Picture Quality Adjustments

## Main Menu

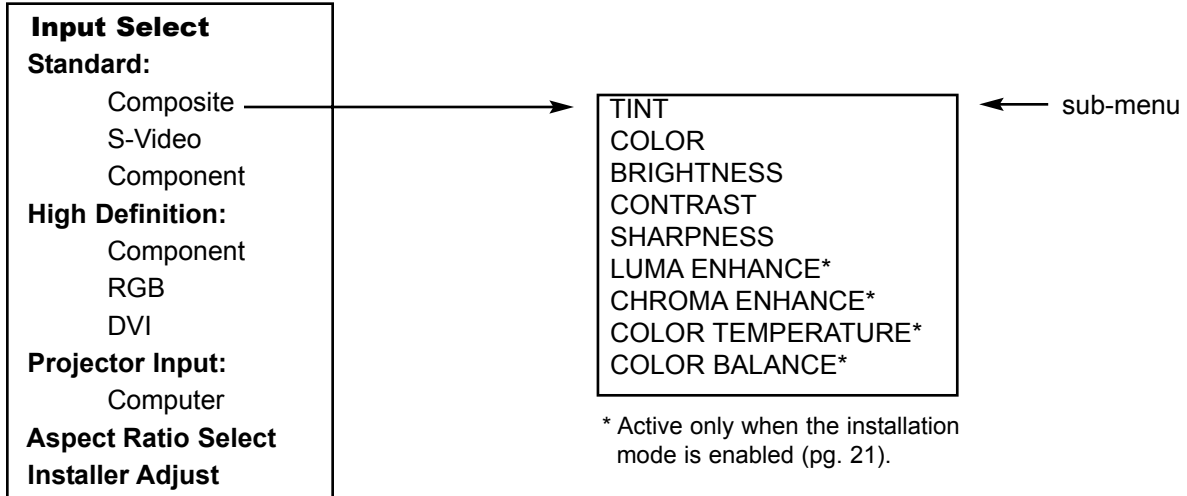

Picture quality adjustments are the controls that change different parameters of the image such as the amount of color, black level, etc. While these adjustments can be set to suit the needs of the user, there is a way to set these properly. This section will describe what each function does and how to adjust them properly.

To access the Picture Quality Adjustments, press MENU, highlight the active source (indicated by the arrow) and press ENTER. The picture quality sub-menu will then appear (see above).

To make an adjustment to a particular function, highlight the function with the up or down arrow buttons and press ENTER. Once the function is on-screen (i.e. brightness), pressing the UP arrow button on the remote or front panel will increase the value of that function; pressing the DOWN arrow button on the remote or front panel will decrease the value of that function.

While each of the picture quality adjustments can be set to suit the needs of the user, there is a 'proper' way to set the adjustments. For setting TINT and COLOR, please refer to the color bar test pattern below.

**NOTE:** A BLUE FILTER must be used so only the blue color bars can be seen. Blue filters are provided with the Video Essentials or AVIA test DVDs.

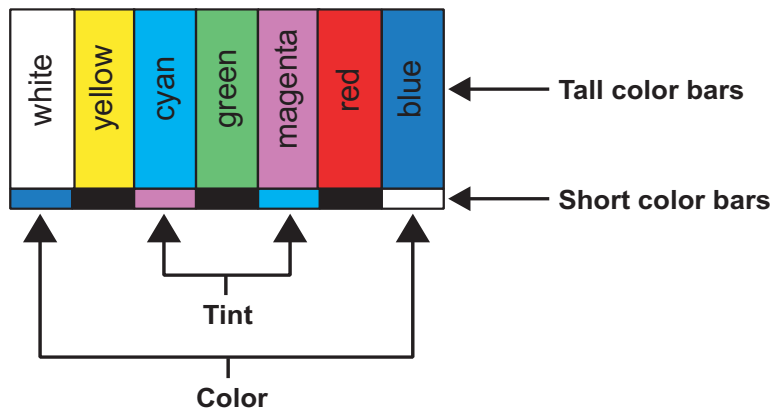

---

**TINT** (also known as 'hue') is essentially the ratio of red to green in the color portion of the image. If TINT is decreased, the image will appear redder, and increasing it will cause the image to appear greener. To set TINT properly, look at the color bar pattern through a blue filter (or mute the red and green outputs). Adjust TINT until the middle two tall color bars match the middle short color bars (see color bar drawing).

**COLOR** (also known as 'saturation') increases or decreases the amount of color in the image. To set COLOR properly, look at the color bar pattern through a blue filter (or mute the red and green outputs). Adjust COLOR until the outer two tall color bars match the outer short color bars (see color bar drawing).

For setting **CONTRAST** and **BRIGHTNESS**, please refer to the PLUGE pattern below:

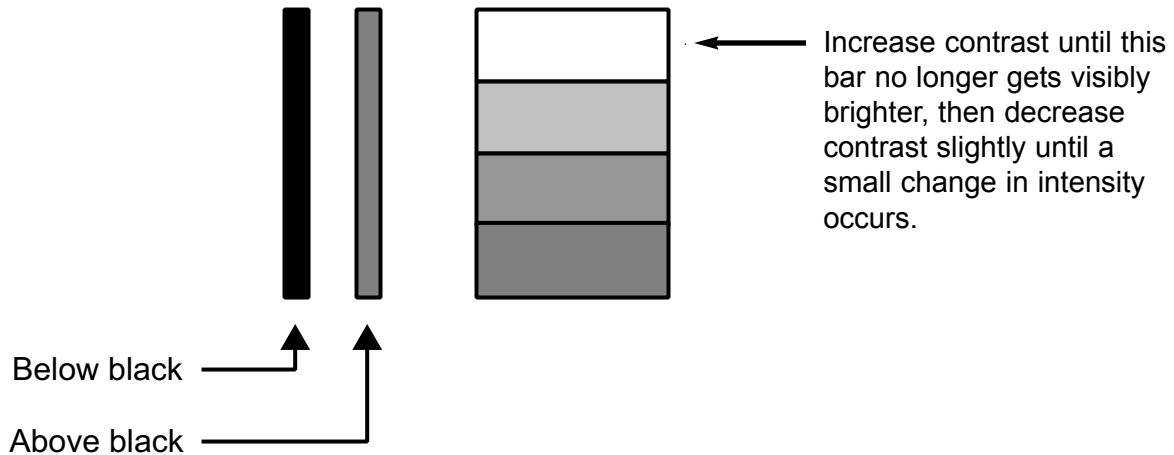

**CONTRAST** adjusts the white level of the image. Adjust contrast until there is a distinct definition between the two brightest bars.

**BRIGHTNESS** adjusts the black level of the image. To adjust this properly, adjust BRIGHTNESS until the 'below black' bar JUST disappears, but the 'above black' bar is still barely visible.

**NOTE:** Some DVD players cannot pass the 'blacker than black' bar (they won't pass PLUGE), and that bar will never be visible. In a case like this, adjust the 'above black' bar until it is slightly brighter than the background that surrounds it.

---

**SHARPNESS** adjusts the amount of high-frequency detail in the image. This can be adjusted to the preference of the user. Keep in mind that when SHARPNESS is decreased, fine details in the image will become 'soft'; when it is increased, fine details will become sharper but will also make the picture appear 'noisy' if adjusted too high.

**LUMA ENHANCE\*** acts as an edge enhancement, especially around black to white transitions in the image. Essentially, this has the same characteristics as sharpness but affects the edges of objects far more than the rest of the image.

FREQUENCIES HIGH/LOW affect the overall range of the LUMA ENHANCE feature. For example, if using a lower-quality video source such as a VCR, the FREQUENCIES should be set to LOW. For a good quality source such as a DVD player, set FREQUENCIES to HIGH. To set FREQUENCIES, press ENTER while LUMA ENHANCE is on-screen.

**CHROMA ENHANCE\*** acts as an edge enhancement, especially around color transitions in the image. Essentially, this has the same characteristics as sharpness but affects the edges of objects far more than the rest of the image.

FREQUENCIES HIGH/LOW affect the overall range of the CHROMA ENHANCE feature. For example, if using a lower-quality video source such as a VCR, the FREQUENCIES should be set to LOW. For a good quality source such as a DVD player, set FREQUENCIES to HIGH. To set FREQUENCIES, press ENTER while CHROMA ENHANCE is on-screen.

**COLOR TEMPERATURE\*** sets the overall color temperature of the image. The range is from 55 to 115. Multiply by 100s for approximate color temperature 5500 - 11500°K.

**COLOR BALANCE\*** adjusts the actual grey scale of the image. You may adjust the amount of Red, Green or Blue in the image as needed. There are 9 adjustments: GAMMA is 30-70% Gray, OFFSET is 1-29% and GAIN is 70-100% GRAY.

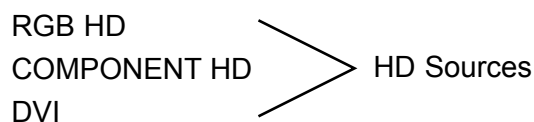
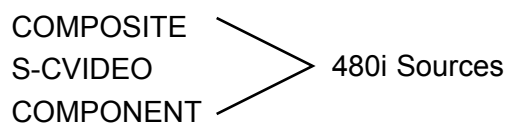

\* 480i and HD Sources can be adjusted separately

\* **Active only when the Installation mode is enabled (page 21).**

# Installation Menu

## Installation Menu

The Installation menu is where you can adjust the Picture Orientation, Keystone, Lamp Output, and even check the age of the lamp in the Projector.

When the **Controller** is turned on for the first time, the INSTALLATION item will not appear in the main menu. To enable the INSTALLATION menu, there are two options:

1) With the processor ON and no menus on-screen, simultaneously press the *ENTER*, *UP* and *LEFT* buttons (you do not need to hold them down). Release the three buttons and press MENU, ensure INSTALLATION is now on the bottom of the main menu.

2) With the remote control, press button 6 (with no menus on-screen). After pressing '6', press MENU and ensure INSTALLATION is now on the bottom of the main menu.

After INSTALLATION has been accessed, press MENU, highlight INSTALLATION and press *ENTER*. This will bring up the INSTALLATION MENU, shown on the right:

<b>INSTALLATION</b>	
Lamp Mode	
Keystone	
Picture Orientation	
IR Code Set	
.....	
Lamp Hours	20

## Lamp Mode

The Lamp Mode enables the installer to set the lamp for full brightness (normal) or Low (20% lower). If a small screen is being used in a dark area or the image is otherwise too bright, it may be a good idea to set the Lamp Mode to LOW. When the Lamp Mode is set to LOW, the lamp will last longer as a result of the lower current setting.

## Keystone

KEYSTONE: Corrects the trapezoidal distortion that results from projecting at an angle:

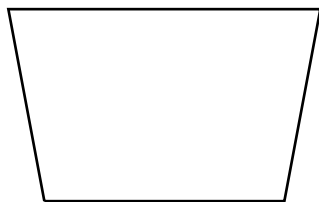

An image with **Keystone** error

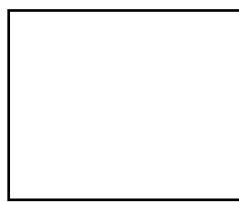

A correctly adjusted image

This may occur in installations where the projector needed to be angled as a result of a larger vertical offset. This keystone feature will correct for trapezoidal distortion for as much as a 15° projector angle.

## Picture Orientation

This will set the orientation of the image for your installation. If the Projector will be mounted on a table, set this for **Floor**. If mounting it on the ceiling, select **Ceiling**. For two-mirror or 'straight-shot' rear-screen applications, select floor rear or ceiling rear as appropriate.

---

## IR Code Set

IR Code Set allows the installer to choose from one of four different sets of IR codes. If the default code has commands that are conflicting other equipment, try using one of the other code sets.

When IR CODE SET is selected in the menu, you will get four code set options- 013, 215, 510 and 918. These numbers correspond to the number that is programmed into the remote control itself (see pg. 13). For example, if you wish to use IR code set 510, you would first select '510 code set' from the menu, then program the remote for code 510 (as described on pg. 13). You may also disable the IR receiver on the Controller all together by selecting 'Deactivated'. **In the event the Controller has been reset (see 'system reset' below), the IR code set will default to 013.**

'Menu/Enter' invert allows the menu and enter buttons on the remote to reverse their functions; if 'YES' is selected, the menu button will become the enter button, and the enter button will become the menu button. This affects the remote ONLY.

## Lamp Hours

Lamp Hours displays the number of hours the lamp has been in use. With the VX-1000ci, the lamp life is around 2000 hours. This should be checked periodically to keep track of the lamp's age, and when the lamp is around 1800 hours old, a new one should be installed to prevent lamp failure, including implosion.

At approximately 1900 hours the word "**LAMP**" will appear on screen indicating that the lamp is near the end of its expected lifespan. Failure to replace this lamp before 2000 hours will result in a system shutdown. Should this occur your projector will need to be serviced by a qualified service technician or at the factory. This is a safety feature to project the light engine from lamp implosion.

Warning Lamp Monitor



## System Reset

In the event that your **Controller** appears to have a software problem, or adjustments have been made so far out of range that the image is no longer on-screen or discernable, you can reset it back to factory values. This sets ALL settings back to factory values, so any adjustments made previously will be lost.

### To reset your VX-1000ci Controller, follow this procedure:

- Turn off the MAIN POWER switch on the back of the processor
- Hold down the DOWN ARROW button, and turn the MAIN POWER SWITCH back on. Continue holding the down arrow button until the LED on the front panel blinks, then release the down arrow button. Once this is done, your processor has been completely reset to factory values. After resetting the unit, Composite video will be the active source.

**Note:** If a system reset is performed, the IR Code Set will default to 013.



# Quick Menu

---

The 'Quick Menu' allows you to make adjustments to the displayed image without having to go through the standard menu.

**The Quick Menu allows the adjustment of Brightness, Contrast, Color, Tint, Sharpness, Image Shift, Color Temperature and 9 point Color Balance with any of the three standard inputs (Composite, S-Video, Component) or Component HD. In RGB HD or DVI, only Brightness, Contrast, Shift, Color Temperature and 9 point Color Balance are available.**

To use the quick menu, press ENTER on the front panel, and observe the front panel display. The following will be displayed (except the DVI input):

**Quick Menu: BRIGHTNESS**  
**Press arrows or enter...**

The first mode of the Quick Menu is BRIGHTNESS. When this is displayed, press the up or down arrows to adjust the brightness. For all of the adjustments, the quick menu will time-out 10 seconds from the last button press, so ensure that you make the adjustments within that time.

If you do not need to make any brightness adjustments or you have completed making them, press ENTER again to display the next mode of the shift menu, which is for CONTRAST (except the DVI input):

**Quick Menu: CONTRAST**  
**Press arrows or enter...**

To adjust CONTRAST, press the up or down arrow buttons. Once the adjustments have been completed, or no adjustment was needed, press ENTER. The next mode of the quick menu will be displayed, which is for COLOR (except RGB and DVI inputs):

**Quick Menu: COLOR**  
**Press arrows or enter...**

To adjust COLOR, press the up or down arrow buttons. Once the adjustments have been completed, or no adjustment was needed, press ENTER to display the next mode of the Quick Menu, which is TINT (except RGB, Computer and DVI inputs).

---

**Quick Menu: TINT**  
**Press arrows or enter...**

To adjust TINT, press the up or down arrows. Once the adjustment has been completed or no adjustment was needed, press ENTER to display the next mode of the Quick Menu, which is SHARPNESS (except the RGB, Computer and DVI inputs).

**Quick Menu: SHARPNESS**  
**Press arrows or enter...**

To adjust SHARPNESS, press the up or down arrows. Once the adjustment has been completed or no adjustment was needed, press ENTER to display the final mode of the Quick Menu, which is SHIFT (except the DVI input).

**Quick Menu: SHIFT**  
**Press arrows or enter...**

To adjust SHIFTING, press the up, down, left or right arrows to shift the image in the desired direction. When the adjustments have been made, press ENTER to exit the Quick Menu, If you need to touch up any of the Quick Menu items, press ENTER to re-enter the Quick Menu (except the DVI input).

**RED GAIN**

**GREEN GAIN**

**BLUE GAIN**

**RED OFFSET**

**GREEN OFFSET**

**BLUE OFFSET**

**RED GAMMA**

**GREEN GAMMA**

**BLUE GAMMA**

**COLOR TEMP**

# Basic Troubleshooting Tips

---

The following is a basic troubleshooting guide that can assist you in resolving typical problems may result in normal operation. If you have encountered problems that are not listed in this guide, please contact your Runco dealer for assistance.

<b>PROBLEM</b>	<b>POSSIBLE CAUSE</b>	<b>SOLUTION</b>
<p><b>The Projector does not turn on after initial installation. The Power LED on the front of the Controller stays yellow after the power button is pressed.</b></p>	<ul style="list-style-type: none"> <li>• The RJ-11 (ComLink) cable is not connected between the Controller and Projector, or is made improperly.</li> <li>• The projector is not plugged in, or its AC outlet is not active. Look at its power LED and see if it is illuminated.</li> <li>• Incorrect phone cord</li> </ul>	<ul style="list-style-type: none"> <li>• Use a standard RJ-11 phone-type cord. Ensure it is firmly plugged into both the Controller and the Projector.</li> <li>• Ensure there is good continuity in the RJ-11 cable.</li> <li>• Verify that the AC outlet is active, or that the Projector is plugged in.</li> </ul>
<p><b>The Projector and Controller are both on, but there is no video image on-screen.</b></p>	<ul style="list-style-type: none"> <li>• The Controller is on the wrong source.</li> <li>• The Controller is on the correct source, but the source itself is off.</li> </ul>	<ul style="list-style-type: none"> <li>• Press MENU on the Projector's remote, and look to see which source is active (the arrow will be pointing to the active source). Select the correct source as appropriate.</li> <li>• Turn on the source. It is recommended that all sources be turned on first BEFORE the VX-1000ci.</li> </ul>
<p><b>The Projector is producing a 'split screen' or an otherwise scrambled image.</b></p>	<ul style="list-style-type: none"> <li>• A progressive scan DVD is plugged into Component input rather than the RGB/Component input.</li> </ul>	<ul style="list-style-type: none"> <li>• Only NTSC/PAL can be input to the Component input. Progressive scan must go into RGB/Component.</li> </ul>
<p><b>The image appears too bright, and there is a loss of definition in the brightest areas of the image.</b></p>	<ul style="list-style-type: none"> <li>• Contrast is set too high.</li> <li>• The DVD player is set for a high-level output.</li> <li>• The video signal has not been terminated properly somewhere in the system.</li> </ul>	<ul style="list-style-type: none"> <li>• Turn down the CONTRAST level on the Controller. Mid-range is 127; it is recommended to keep it below 140 to prevent this problem.</li> <li>• Set the DVD player for a nominal output (no boost or gain).</li> <li>• Ensure all video signals are terminated in 75 Ohms.</li> </ul>

<p><b>The image appears too 'washed out', or the darkest areas of the image appear too bright.</b></p>	<ul style="list-style-type: none"> <li>· Brightness is set too high.</li> <li>· The DVD player may be set for too high of a brightness level.</li> </ul>	<ul style="list-style-type: none"> <li>· Turn down the BRIGHTNESS level on the Controller. If possible, use a PLUGE pattern to set the brightness level properly.</li> <li>· Set the DVD player for a nominal output (no boost or gain).</li> </ul>
<p><b>The colors of the image appear abnormal</b></p>	<ul style="list-style-type: none"> <li>· The Red, Green and/or Blue outputs of the Controller or inputs to the Projector are reversed.</li> <li>· The Pr and Pb inputs on the Component input on the Controller are reversed</li> </ul>	<ul style="list-style-type: none"> <li>· Check the cable connections on the back of the Controller or on the Projector.</li> </ul>
<p><b>The image appears keystoneed (trapezoidal).</b></p>	<ul style="list-style-type: none"> <li>· The Projector has been mounted too high or too low in respect to its vertical offset.</li> </ul>	<ul style="list-style-type: none"> <li>· Adjust Keystone, see page 21.</li> </ul>
<p><b>The Projector will not turn on, and the power LED on the front of the Controller is blinking red.</b></p>	<ul style="list-style-type: none"> <li>· The Controller may have 'locked-up'.</li> </ul>	<ul style="list-style-type: none"> <li>· Unplug the Controller for 2 minutes; plug it back in a re-try.</li> <li>· Perform a system reset on the Controller (see page 22), and then re-try.</li> </ul>
<p><b>The Projector will not turn back on after it was powered-down, or the image disappears during operation.</b></p>	<ul style="list-style-type: none"> <li>· The Projector will not turn on for two minutes after power-down to protect its bulb.</li> <li>· The bulb has failed</li> </ul>	<ul style="list-style-type: none"> <li>· Wait two minutes until the LED on the front of the Controller turns red.</li> </ul>

# RS-232 Communications

---

## General Information

**Baud rate:** 9600 (fixed)

**Bits:** 8

**No Parity**

**All protocol in ASCII format**

**RS-232 input connector pin numbers:** TxD= Pin# 2, RxD= Pin# 3, GnD= Pin# 5

**Command format (single command):** command value (i.e. brightness 30).

**NOTE:** A space (not an underscore) or comma may be used between the command and its value.

**Command string format:** command,command value, command etc.  
(i.e. COMPOSITE,BRIGHTNESS 30,ANAMORPHIC,<CR>)

**NOTE:** In between commands, a comma must be used; a comma or space may be used in between a command and its value.

**NOTE:** A carriage return must be used after each command or string.

### **Other notes:**

- For command strings, a maximum of 255 characters can be used in a single string.
- If it is necessary to input multiple commands, they should all be together in a single string. Inputting commands one at a time requires a 15 second delay between commands, as the information is stored into non-volatile memory after each command.
- For values not automatically stored (see next paragraph), the command "!STORE" must be sent in order for the **PFP Controller** to keep the settings. Otherwise, the values will be considered temporary and will revert to their stored settings upon source change or power-up.
- The "Value stored" column refers to a command that is either automatically stored or if it must be manually stored with the "!STORE" command.
- PARAMETER min/max refers to a function's minimum and maximum value range. Inputting values above or below their range may cause unpredictable (but not fatal) results.
- When connecting RS-232 to the Controller, you may have to add a delay in between characters. For example in an AMX system you would add the following line:

```
(*****  
(*          STARTUP CODE GOES BELOW          *)  
(*****  
DEFINE_START  
  
SEND_COMMAND PFP,'SET BAUD 9600,N,8,1'  
SEND_COMMAND PFP,'HSOFF'  
SEND_COMMAND PFP,'"CHARD-200"' (* SETS DELAY IN MICROSECONDS BETWEEN CHARACTERS *)
```

This will increase the reliability in receiving the code. For other systems you may have to contact the manufacturer to find out how to set the delay.

# RS-232 Commands

---

COMMAND	PARAMETER (min/max)	Value stored?	DESCRIPTION
ON	NA	NA	Turns PFP Controller on
OFF	NA	NA	Turns PFP Controller off
COMPOSITE	NA	YES	Selects the Composite video input
SVIDEO	NA	YES	Selects the S-Video input
COMPONENT	NA	YES	Selects the Component input
HDRGB	NA	YES	Selects the RGB HD input
HDCOMPONENT	NA	YES	Selects the Component HD input
DVI	NA	YES	Selects the DVI input on the Projector
ANAMORPHIC	NA	YES	Selects the anamorphic aspect ratio
STANDARD	NA	YES	Selects the standard (4:3) aspect ratio
LETTERBOX	NA	YES	Selects the letterbox aspect ratio
VIRTUALWIDE	NA	YES	Selects the VirtualWide aspect ratio
TINT	-127/127 (HD-30/30)*	NO	Sets a value for tint
COLOR	-127/127 (HD-30/30)*	NO	Sets a value for color
AGCCOLOR	0/1	NO	0=Disable Color AGC 1=Enable Color AGC
BRIGHTNESS	-30/30	NO	Sets a value for brightness
CONTRAST	-30/30	NO	Sets a value for contrast
AGCCONTRAST	0/1	NO	0=Disable Contrast AGC 1=Enable Contrast AGC
SHARPNESS	0/255 (HD-30/30)*	NO	Sets a value for sharpness
CHROMAHIGH	0/127	NO	Sets a value for high-frequency chroma edge enhancement
CHROMALOW	0/127	NO	Sets a value for low-frequency chroma edge enhancement
LUMAHIGH	0/127	NO	Sets a value for high-frequency luminance edge enhancement
LUMALOW	0/127	NO	Sets a value for low-frequency luminance edge enhancement
TEMPERATURE	55/115	NO	Selects the Projector's color temperature

\* These parameters are applicable only in the HD Component mode.

<b>COMMAND</b>	<b>PARAMETER (min/max)</b>	<b>Value stored?</b>	<b>DESCRIPTION</b>
!STORE	NA	YES	Stores the current set of values (all values) into non-volatile memory
!RESTORE	NA	YES	Restores the stored values
!FACTORY	NA	YES	Restores all values to factory default levels
!STATUS	NA	NA	Asks the Controller to provide the hardware information, current values and system status to the automation system
!RESTART	NA	NO	Restarts the PFP Controller (same as turning it on and off)
!ECHO	NA	NO	Enables the Controller to echo back commands and values to the automation system
!NOECHO	NA	NO	Disables the Controller's character echoing
!INSTALLMODEOFF	NA	NA	Disables the Installation menu (removes it from the main menu)
!INSTALLMODEON	NA	NA	Enables the Installation menu (enables it on the main menu)
!SERVICEMODEON	NA	NA	Enables the service mode
!SERVICEMODEOFF	NA	NA	Disable the service mode
RGAIN	-30/30	NO	Adjust the Red level of image
GGAIN	-30/30	NO	Adjust the Green level of image
BGAIN	-30/30	NO	Adjust the Blue level of image
ROFFSET	-30/30	NO	Adjust the Red level of image
GOFFSET	-30/30	NO	Adjust the Green level of image
BOFFSET	-30/30	NO	Adjust the Blue level of image
RGamma	-30/30	NO	Adjust the Red gamma of image
GGamma	-30/30	NO	Adjust the Green gamma of image
BGamma	-30/30	NO	Adjust the Blue gamma of image
IRCODE	013	NO	Changes the IR Code Set of the Controller to 013
IRCODE	215	NO	Changes the IR Code Set of the Controller to 215
IRCODE	510	NO	Changes the IR Code Set of the Controller to 510
IRCODE	918	NO	Changes the IR Code Set of the Controller to 918
IRCODE	0	NO	Disables the IR receiver

# VX-1000ci Projector Dimensions

## Top View

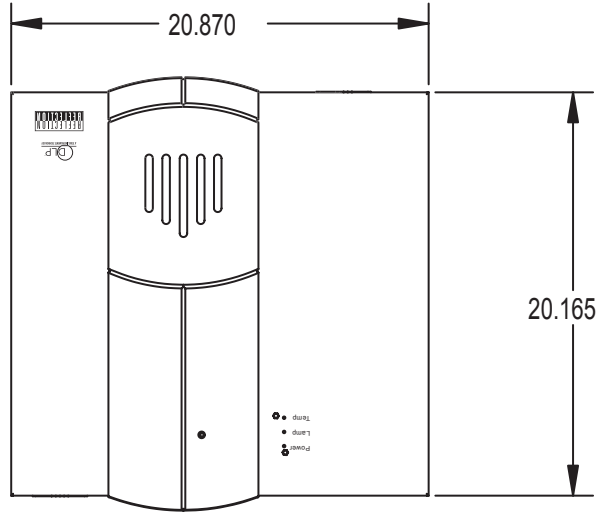

## Front View

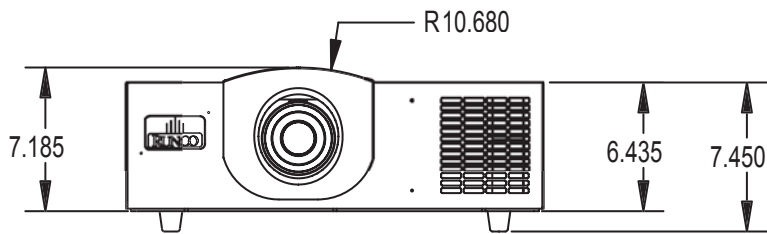

## Bottom View

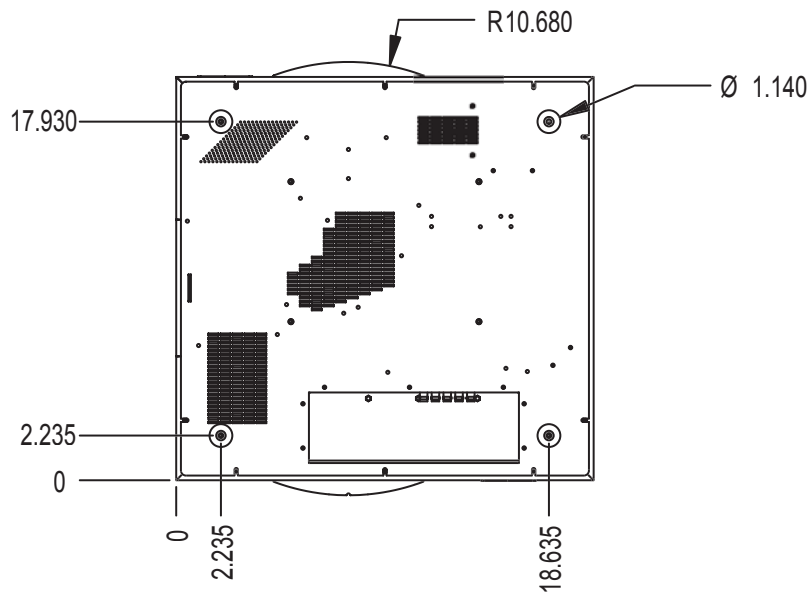



# PFP Controller Dimensions

## Front Panel

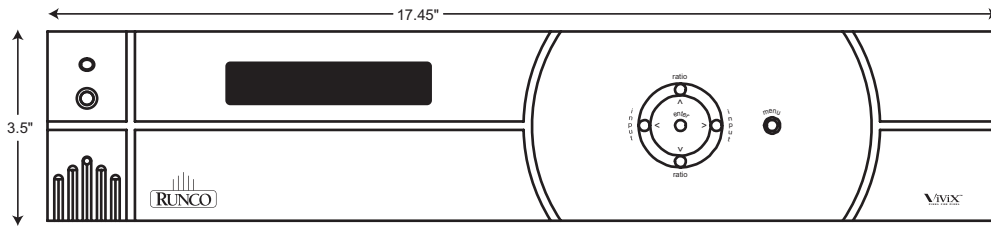

## Rear Panel

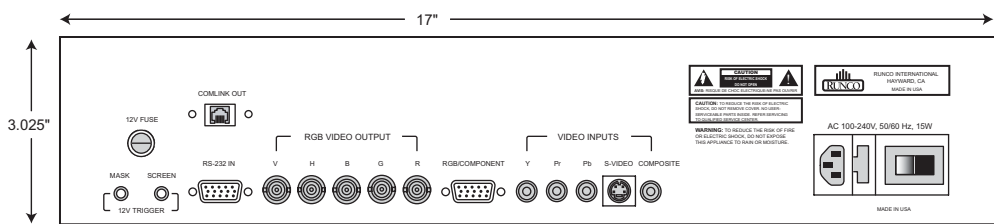

## Top Panel

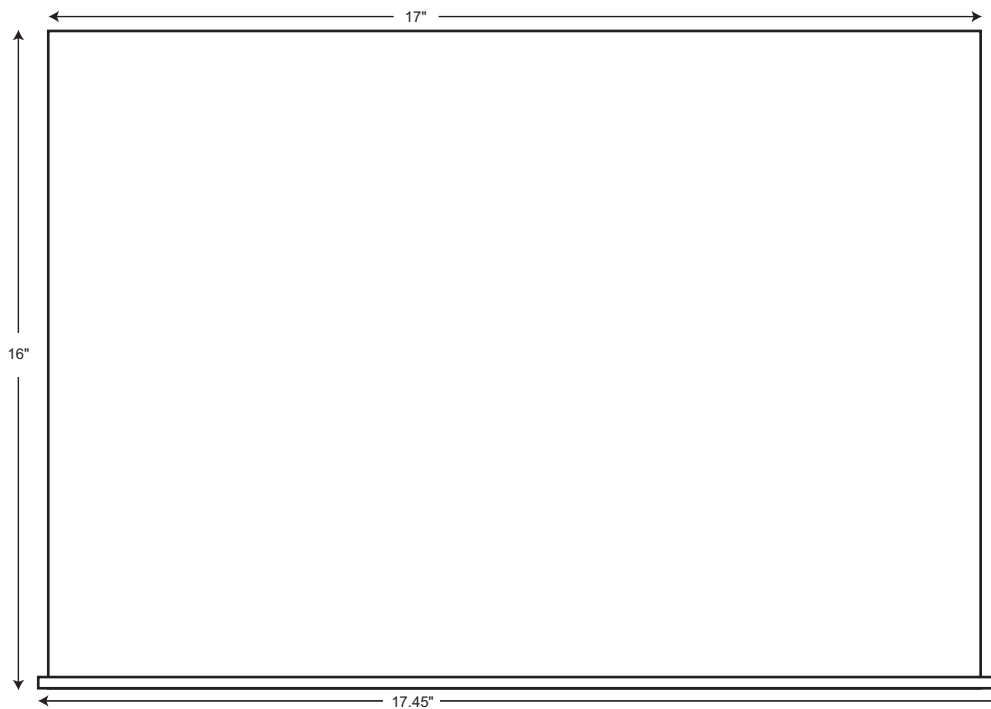

## Side Panel

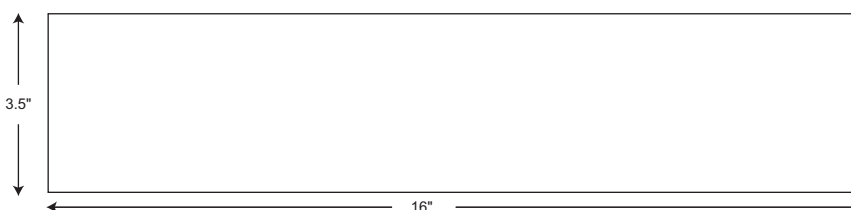

# Specifications

---

## VX-1000ci Projector:

<b>Projector Type:</b>	Digital Light Processing™ (DLP)™, Single HD2 DMD Chip
<b>Native Resolution:</b>	1280 x 720 (Designed for 16:9 screens only)
<b>Aspect Ratio:</b>	Determined by supplied processor
<b>Video Standards:</b>	NTSC, PAL
<b>DTV Compatibility:</b>	480p, 720p, 1080i
<b>Scan Frequency:</b>	Horizontal: 15-81 KHz, Vertical: 43-100 Hz
<b>Picture Size:</b>	Recommended Width: 72-96 in. Maximum Width: 200 in. wide (16:9 screen)
<b>Throw Distance:</b>	Minimum: Zoom 1.85 x screen width Maximum: Zoom 2.40 x screen width
<b>Horizontal/Vertical Offset:</b>	Horizontal: 0, Vertical +/- 50%
<b>Light Output:</b>	1500 ANSI Lumens CSMS Specifications: Home Theater Calibration: 418-600 ANSI Lumens Foot-Lamberts: 15.6-22.4 (Variable depending on RVR calibration)
<b>Contrast Ratio:</b>	2500:1 to 3000:1 CSMS Contrast Ratio: 177:1 to 178:1 (Variable depending on RVR calibration)
<b>Lamp:</b>	250W NSH
<b>Lamp Life:</b>	2000 hours @ 6500° Kelvin
<b>Inputs:</b>	<b>Projector:</b> (1) RGB HV, (1) DVI w/HDCP, (1) RS-232 <b>Controller:</b> (1) Composite, (1) S-Video, (1) Component, and (1) Pass-through
<b>12V Output:</b>	See Controller for specifications
<b>Power Requirements:</b>	115V AC, 50/60 Hz 100-240V AC, 375W
<b>Operating Environment:</b>	40°- 95° F, (5°- 35° C), 0%-90% Humidity (non-condensing)
<b>Dimensions:</b>	Width: 20 7/8 in. (530.20 mm) Depth: 21 5/8 in. (550.20 mm) Height: 6 1/2 in. (165.10 mm), with feet 8 1/4 in. (209.50 mm) Weight: 50 lbs. (22.7 kg), (includes lens)
<b>Regulatory Approvals:</b>	Complies with FCC Class B, CE, C-Tick
<b>Limited Warranty:</b>	<b>Projector:</b> (2) Two year parts and labor from the date of delivery to the end user <b>Lamp Warranty:</b> 1000 hours or (6) six months, which ever comes first.

---

## **PFP Controller:**

<b>Inputs:</b>	Composite, S-Video, Component, RGB/Component HD
<b>Input standards:</b>	NTSC (NTSC/PAL International Version)
<b>Aspect Ratios:</b>	Anamorphic, 4:3, Letterbox (16:9 screens only), VirtualWide
<b>Control Options:</b>	RS-232, Infrared, Front Panel
<b>Bandwidth:</b>	5.5 Mhz (Composite, S-Video, Component inputs); 100Mhz (pass-through)
<b>Operating Environments:</b>	41°-95°F (5°-35°C); 0-90% humidity (non-condensing)
<b>Dimensions:</b>	Width: 17 1/2 in. (444.50 mm) Depth: 16.0 in. (406.40 mm) Height: 3 1/2 in. (88.90 mm) Weight: 16 lbs. (7.3 kg)
<b>Power Requirements:</b>	100-120 VAC (200-240VAC Export version); 15W
<b>Regulatory Approvals:</b>	Complies with FCC Class B, CE, C-Tick
<b>Limited Warranty:</b>	<b>Service Labor and Parts:</b> Runco warrants the product for two years from the date of delivery to the end user.

## **Supplied Accessories**

- Remote Control with 2 AAA batteries
- Rack Mount hardware
- (1) 6" RGBHV extension for the Controller, (1) 9-pin to RJ-45
- Power cables (one for Projector, one for PFP Controller)
- 50' RJ-11 phone type cable
- Lens adjustment tool
- User's Manual
- Warranty information



RUMA-008300 rev 4-03



**THE WORLD'S FINEST HOME THEATER PRODUCTS™**

Runco International • 2900 Faber Street • Union City, CA 94587 • ph (510) 324-7777 • fax (510) 324-9300 • [www.runco.com](http://www.runco.com)